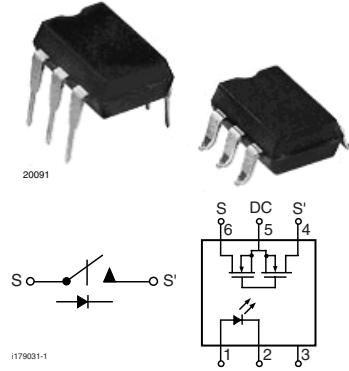

1 Form A Solid State Relay

Features

- High speed SSR - $t_{on}/t_{off} < 800 \mu s$
- Maximum $R_{ON} 0.25 \Omega$
- Isolation test voltage 5300 V_{RMS}
- Load voltage 60 V
- Load current 2 A DC configuration
- DIP-6 package
- Clean bounce free switching
- TTL/CMOS compatible input
- Available on tape and reel
- Pure tin leads

RoHS
COMPLIANT

Description

The VO14642AT are high speed SPST normally open (1 Form A) solid-state relay in a DIP-6 package. The relays are constructed as a multi-chip hybrid device. Actuation control is via an Infrared LED. The output switch is a combination of a photodiode array with MOSFET switches. The relays can be configured for AC/DC or DC only operation.

Agency Approvals

- UL1577, file no. E52744 system code H or J, double protection
- CUL - UL1577, file no. E52744 system code H or J, double protection
- VDE DIN EN 60747-5-2 (VDE0884)

Applications

- Instrumentation
- Industrial controls
- Security

Order Information

Part	Remarks
VO14642AABTR	Tape and reel, SMD-6
VO14642AT	Tubes, DIP-6

Absolute Maximum Ratings

$T_{amb} = 25 \text{ }^\circ\text{C}$, unless otherwise specified.

Stresses in excess of the absolute maximum ratings can cause permanent damage to the device. Functional operation of the device is not implied at these or any other conditions in excess of those given in the operational sections of this document. Exposure to absolute maximum ratings for extended periods of the time can adversely affect reliability.

Input

Parameter	Test condition	Symbol	Value	Unit
LED continuous forward current		I_F	50	mA
LED reverse voltage		V_R	5.0	V
LED power dissipation	at 25 $^\circ\text{C}$	P_{diss}	80	mW

Output

Parameter	Test condition	Symbol	Value	Unit
DC or peak AC load voltage		V_L	60	V
Output power dissipation	at 25 $^\circ\text{C}$	P_{diss}	250	mW

Coupler

Parameter	Test condition	Symbol	Value	Unit
Total power dissipation		P_{diss}	330	mW
Ambient temperature range		T_{amb}	- 40 to + 85	°C
Storage temperature range		T_{stg}	- 40 to + 125	°C
Soldering temperature	t ≤ 10 s max.	T_{sld}	260	°C
Isolation test voltage	for 1.0 s	V_{ISO}	3750	V_{RMS}

Absolute Maximum Rating Curve

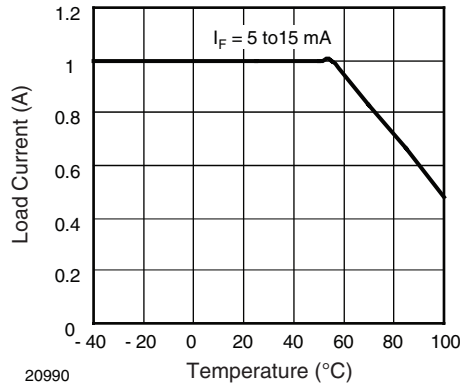
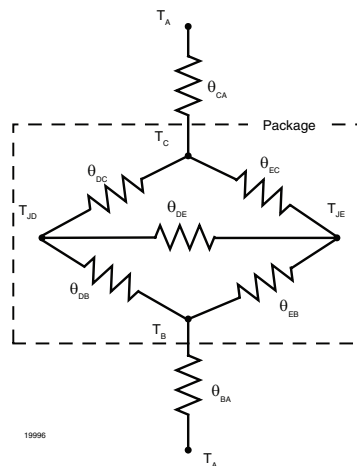

Figure 1. I_{LOAD} vs. Temperature

Thermal Characteristics

The thermal model is represented in the thermal network below. Each resistance value given in this model can be used to calculate the temperatures at each node for a given operating condition. The thermal resistance from board to ambient will be dependent on the type of PCB, layout and thickness of copper traces. For a detailed explanation of the thermal model, please reference Vishay's Thermal Characteristics of Optocouplers Application note.

Parameter	Test condition	Symbol	Value	Unit
Maximum LED junction temperature	at 25 °C	T_{jmax}	125	°C
Maximum output die junction temperature	at 25 °C	T_{jmax}	125	°C
Thermal resistance, junction emitter to board	at 25 °C	θ_{EB}	176	°C/W
Thermal resistance, junction emitter to case	at 25 °C	θ_{EC}	208	°C/W
Thermal resistance, junction detector to board	at 25 °C	θ_{DB}	67	°C/W
Thermal resistance, junction detector to case	at 25 °C	θ_{DC}	134	°C/W
Thermal resistance, junction emitter to junction detector	at 25 °C	θ_{ED}	310	°C/W
Thermal resistance, case to ambient	at 25 °C	θ_{CA}	2180	°C/W



Electrical Characteristics

$T_{amb} = 25\text{ }^{\circ}\text{C}$, unless otherwise specified.

Minimum and maximum values are testing requirements. Typical values are characteristics of the device and are the result of engineering evaluation. Typical values are for information only and are not part of the testing requirements.

Input

Parameter	Test condition	Symbol	Min.	Typ.	Max.	Unit
LED forward current, switch turn-on	$I_L = 1\text{ A}$, $V_L \leq 0.5\text{ V}$, $t = 10\text{ ms}$	I_{Fon}		0.5	2.0	mA
LED forward current, for switch to remain off	$V_L = 60\text{ V}$, $I_L < 1\text{ }\mu\text{A}$	I_{Foff}	50			μA
Input reverse current	$V_R = 5\text{ V}$	I_R			10	μA
LED forward voltage	$I_F = 10\text{ mA}$	V_F	1.0	1.3	1.5	V

Output

Parameter	Test condition	Symbol	Min.	Typ.	Max.	Unit
Peak load voltage		V_L			60	V
Load current DC	$I_F = 10\text{ mA}$	I_L			2	A
Peak load current (AC/DC)	10 ms	I_{LPK}			3.6	A
ON- resistance (AC/DC)	$I_F = 10\text{ mA}$, $I_L = 1\text{ A}$	R_{ON}		0.18	0.25	Ω
ON- resistance (DC only)	$I_F = 10\text{ mA}$, $I_L = 2\text{ A}$	R_{ON}		0.05	0.07	Ω
Off-state leakage current	$I_F = 0\text{ mA}$, $V_L = 60\text{ V}$	I_{LEAK}			1	μA

Pin Configuration

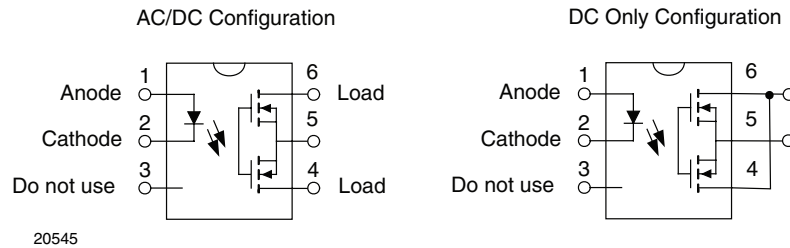

20545

Switching Characteristics (AC/DC Connection)

Parameter	Test condition	Symbol	Min.	Typ.	Max.	Unit
Turn-on time	$I_F = 10\text{ mA}$, $V_L = 30\text{ V}$, $I_L = 200\text{ mA}$	t_{on1}		370	800	μs
Turn-off time	$I_F = 10\text{ mA}$, $V_L = 30\text{ V}$, $I_L = 200\text{ mA}$	t_{off1}		50	800	μs
Turn-on time	$I_F = 10\text{ mA}$, $V_L = 5\text{ V}$, $I_L = 1\text{ A}$	t_{on2}		550		μs
Turn-off time	$I_F = 10\text{ mA}$, $V_L = 5\text{ V}$, $I_L = 1\text{ A}$	t_{off2}		18		μs

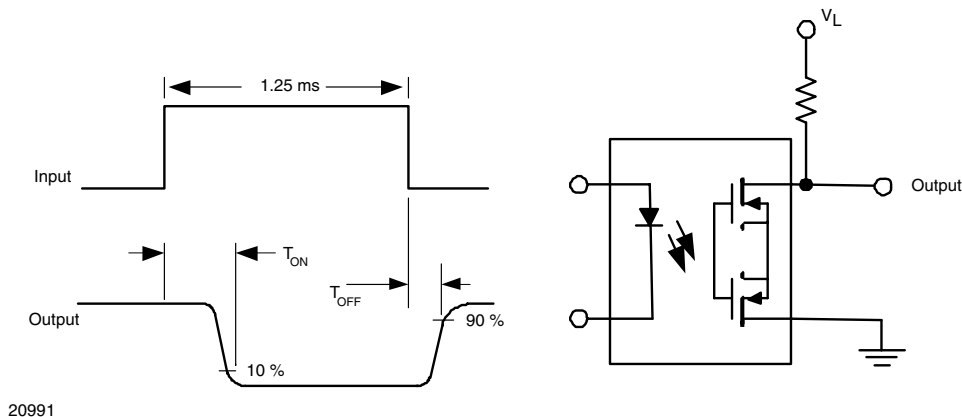

20991

Safety and Insulation Ratings

This SSR is suitable for "safe electrical insulation" only within the safety ratings. Compliance with the safety ratings shall be ensured by means of protective circuits.

Parameter	Test condition	Symbol	Min.	Typ.	Max.	Unit
Climatic classification	IEC 68 part 1			40/85/21		
Pollution degree	DIN VDE 0109			2		
Tracking resistance (comparative tracking index)	Insulation group IIIa	CTI	175			-
Highest allowable overvoltage	Transient overvoltage	V_{IOTM}	8000			V_{peak}
Maximum working insulation voltage	Recurring peak voltage	V_{IORM}	890			V_{peak}
Insulation resistance at 25 °C	$V_{IO} = 500\text{ V}$	R_{IS}			$\geq 10^{12}$	Ω
Insulation resistance at T_S	$V_{IO} = 500\text{ V}$	R_{IS}			$\geq 10^9$	Ω
Insulation resistance at 100 °C	$V_{IO} = 500\text{ V}$	R_{IS}			$\geq 10^{11}$	Ω
Partial discharge test voltage	Method b, $V_{pd} = V_{IORM} \times 1.875$	V_{pd}			1669	V_{peak}
Isolation test voltage	1 s	V_{ISO}			5300	V_{RMS}
Safety limiting values - maximum values allowed in the event of a failure	Case temperature	T_{SI}			165	°C
	Input current	I_{SI}			150	mA
	Output power	P_{SO}			400	mW
Minimum external air gap (clearance)	Measured from input terminals to output terminals, shortest distance through air		≥ 7			mm
Minimum external tracking (creepage)	Measured from input terminals to output terminals, shortest distance path long body		≥ 7			mm

Typical Characteristics

$T_{amb} = 25\text{ °C}$, unless otherwise specified

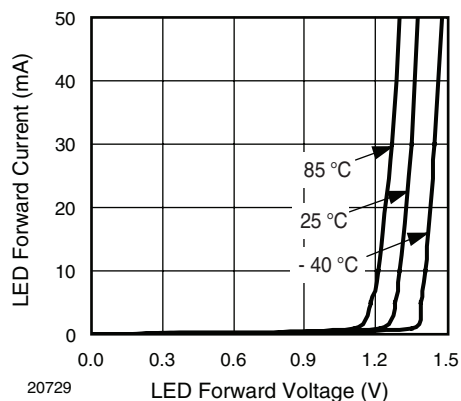

Figure 2. Typical LED Forward Voltage vs. Current

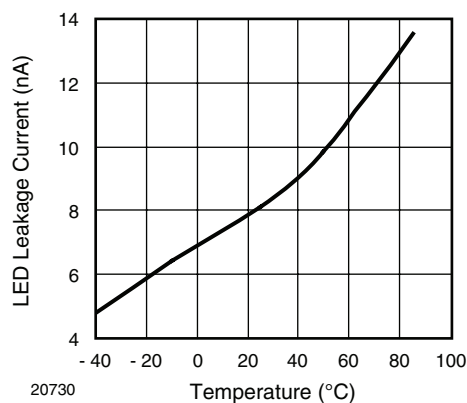
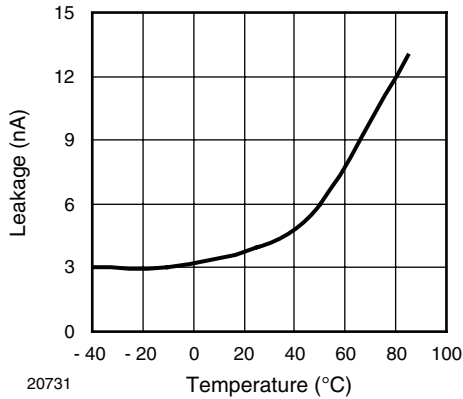
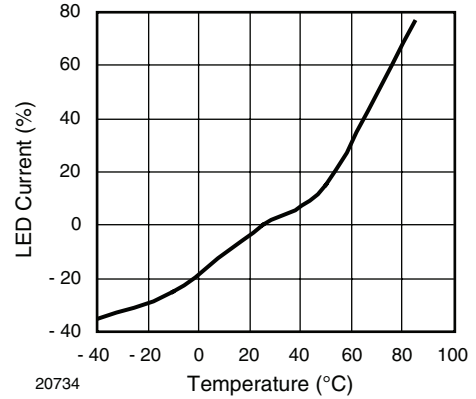

Figure 3. Typical LED Leakage vs. Temperature ($V_R = 5\text{ V}$)



20731
Figure 4. Typical Leakage vs. Temperature
($V_{Load} = 60 V$)



20734
Figure 7. I_F For Switch Operation vs. Temperature
(Normalized to 25 °C, Load Current = 1 A)

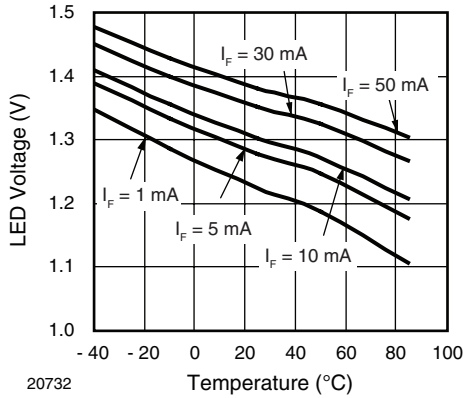

20732
Figure 5. Typical LED Forward Voltage vs. Temperature

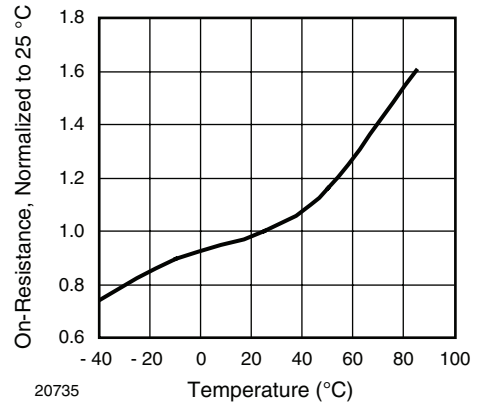

20735
Figure 8. Typical On-Resistance vs. Temperature
(Load Current = 1 A)

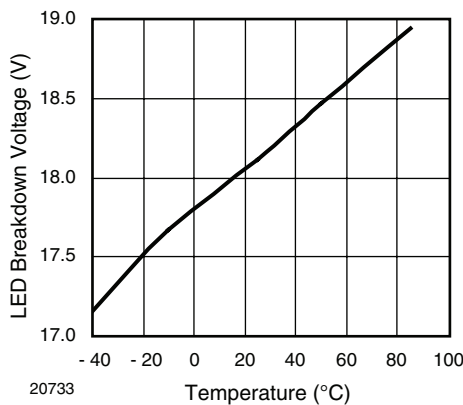

20733
Figure 6. Typical Breakdown Voltage vs. Temperature
($I_L = 5 \mu A$)

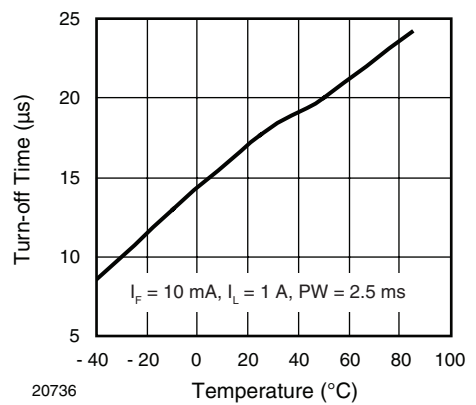

20736
Figure 9. Typical Turn-Off vs. Temperature
(Load Current = 1 A)

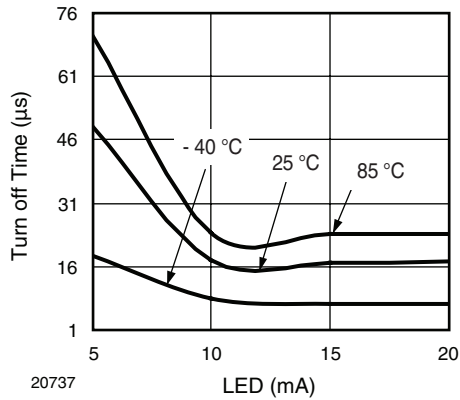

Figure 10. Typical Turn-Off vs. LED Forward Current (Load Current = 1 A)

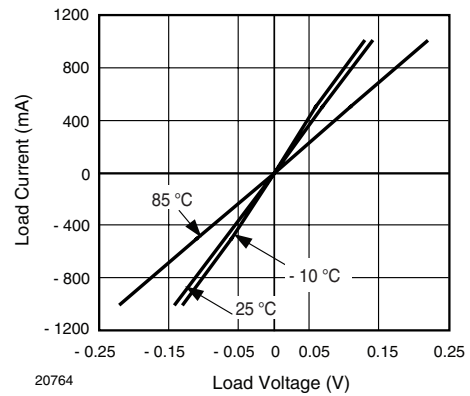

Figure 13. Typical Load Current vs. Load Voltage (LED Current = 10 mA)

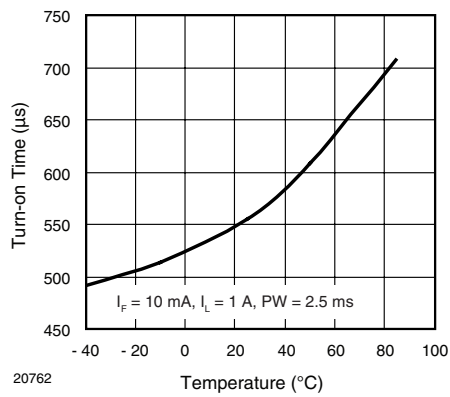

Figure 11. Typical Turn-On vs. Temperature (Load Current = 1 A)

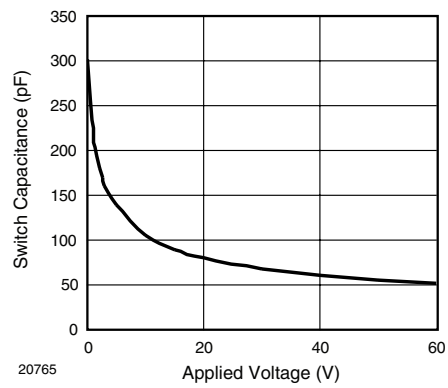

Figure 14. Switch Capacitance vs. Applied Voltage

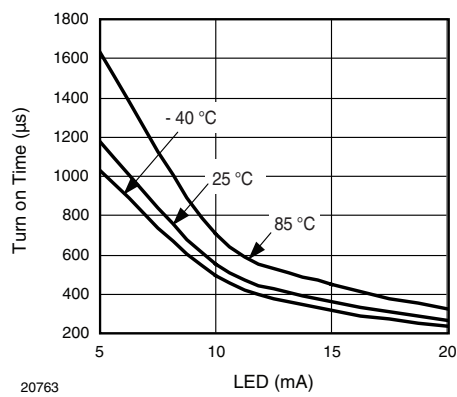
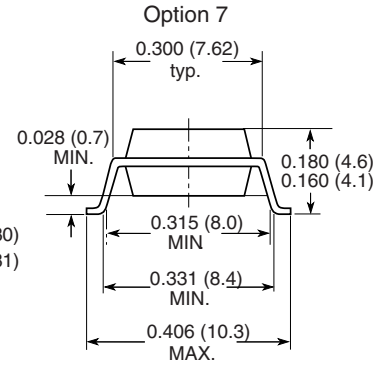
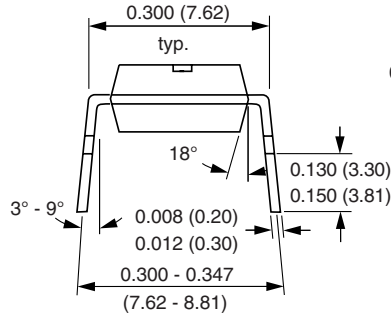
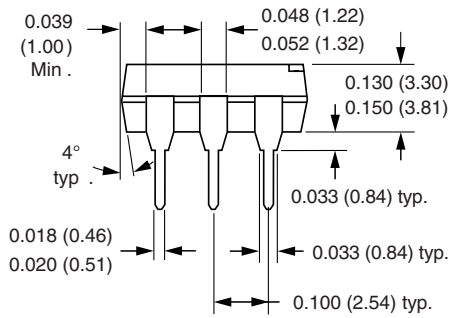
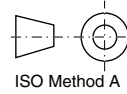
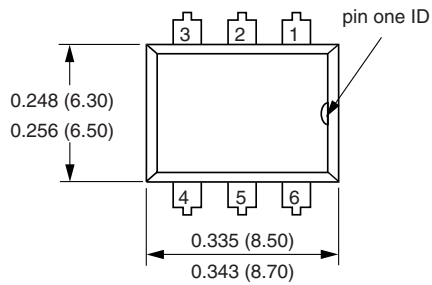

Figure 12. Typical Turn-On vs. LED Forward Current (Load Current = 1 A)



Package Dimensions in inches (millimeters)



i178014_2

Ozone Depleting Substances Policy Statement

It is the policy of Vishay Semiconductor GmbH to

1. Meet all present and future national and international statutory requirements.
2. Regularly and continuously improve the performance of our products, processes, distribution and operating systems with respect to their impact on the health and safety of our employees and the public, as well as their impact on the environment.

It is particular concern to control or eliminate releases of those substances into the atmosphere which are known as ozone depleting substances (ODSs).

The Montreal Protocol (1987) and its London Amendments (1990) intend to severely restrict the use of ODSs and forbid their use within the next ten years. Various national and international initiatives are pressing for an earlier ban on these substances.

Vishay Semiconductor GmbH has been able to use its policy of continuous improvements to eliminate the use of ODSs listed in the following documents.

1. Annex A, B and list of transitional substances of the Montreal Protocol and the London Amendments respectively
2. Class I and II ozone depleting substances in the Clean Air Act Amendments of 1990 by the Environmental Protection Agency (EPA) in the USA
3. Council Decision 88/540/EEC and 91/690/EEC Annex A, B and C (transitional substances) respectively.

Vishay Semiconductor GmbH can certify that our semiconductors are not manufactured with ozone depleting substances and do not contain such substances.

We reserve the right to make changes to improve technical design
and may do so without further notice.

Parameters can vary in different applications. All operating parameters must be validated for each customer application by the customer. Should the buyer use Vishay Semiconductors products for any unintended or unauthorized application, the buyer shall indemnify Vishay Semiconductors against all claims, costs, damages, and expenses, arising out of, directly or indirectly, any claim of personal damage, injury or death associated with such unintended or unauthorized use.

Vishay Semiconductor GmbH, P.O.B. 3535, D-74025 Heilbronn, Germany



Notice

Specifications of the products displayed herein are subject to change without notice. Vishay Intertechnology, Inc., or anyone on its behalf, assumes no responsibility or liability for any errors or inaccuracies.

Information contained herein is intended to provide a product description only. No license, express or implied, by estoppel or otherwise, to any intellectual property rights is granted by this document. Except as provided in Vishay's terms and conditions of sale for such products, Vishay assumes no liability whatsoever, and disclaims any express or implied warranty, relating to sale and/or use of Vishay products including liability or warranties relating to fitness for a particular purpose, merchantability, or infringement of any patent, copyright, or other intellectual property right.

The products shown herein are not designed for use in medical, life-saving, or life-sustaining applications. Customers using or selling these products for use in such applications do so at their own risk and agree to fully indemnify Vishay for any damages resulting from such improper use or sale.